

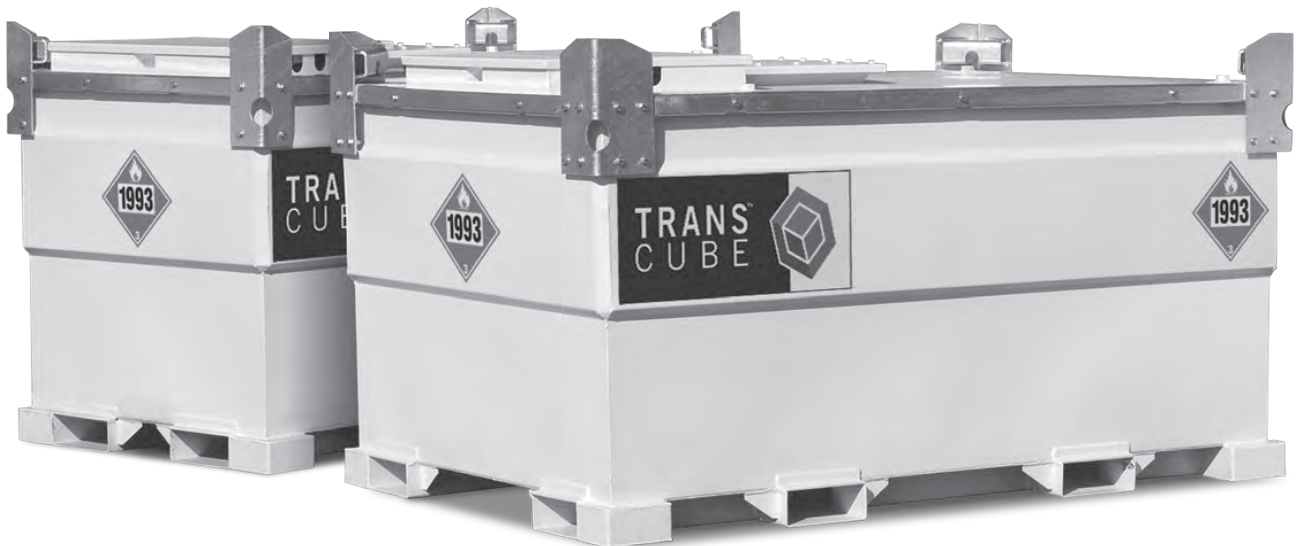

OPERATOR'S MANUAL

MODELS
05TCG
10TCG
20TCG
30TCG
50TCG
(20TCGCAB)



KEEP THESE INSTRUCTIONS WITH THE TRANSCUBE



USER'S NOTICE



- The TransCube was designed for the transport of diesel fuel - UN 1202 / UN 1993.
- It is a double wall Intermediate Bulk Container (IBC).
- Regulation size placards must be on all 4 sides of the TransCube or its means of transport.
- The TransCube was manufactured to the United Nations specifications (eg. 49 CFR Code of Production) tested and certified as a UN Standard Mobile IBC, 31 LAY Packing Group III. This is an international standard recognized by TDG whether made in USA or imported and DOT's code 4 Hazardous Materials Safety (USA).
- **Closures: In transport ALL valves and plugs must be closed. Ensure pump is turned off. The closure system nearest the contents of the IBC must be closed first. Close and lock the hatch-lid.**
- Fill to a maximum of 95% capacity.
- The TransCube must be secured firmly to its means of transport. Do not drill holes in the primary or secondary tanks.
- Replacement of any component must be the same specification or equivalent. Replacement parts can be obtained from Western, Toll free: 866-814-2470, Phone: 203-847-4300 or Fax: 203-847-4310.
- **Compulsory Inspections:** The Transport of Dangerous Goods regulations require the IBC to be inspected every 60 months at a government registered facility. The Record Card must be filled out at each test, and kept with the TransCube. The month and year of the inspection must be stamped in the space provided on the metal specification plate.
- Refer to Operator's Manual for more details. The operator must read and understand Manual before using the TransCube.
- For use on site as a station tank it is UL 142 listed for just storage.

WESTERN INTERNATIONAL, INC.



THE TRANSCUBE MOBILE IBC (INTERMEDIATE BULK CONTAINER) FOR THE TRANSPORT OF DIESEL FUEL ON CANADIAN ROADS.

The UN (United Nations) approved Mobile IBC complies with the following regulations: the UK carriage of dangerous goods by road requirements and the European agreement concerning the international carriage of dangerous goods by road (ADR), US DOT and Transport USA. Transport of Dangerous Goods Regulations apply when transporting the IBC empty or full with flammable liquid of Transport Packing Group III (diesel fuel).

Instructions for Use

1. Ensure that the IBC placard is fitted to all sides with the correct U.N. Number, "Flammable Liquid Class 3 - Hazardous Diamond" and the proper shipping name, i.e. U.N. 1202 for diesel fuel.
2. Ensure that the driver has adequate instruction and training in IBC contents.
3. Ensure driver has appropriate training licence on him or her if required.
4. Ensure documents and Record Cards are carried.
5. Always follow the local or federal road regulations when transporting.
6. Do not allow riders on trailer.
7. Ensure that the TransCube is in good condition and that the certification period has not expired (refer to TransCube Maintenance/Record Card on the date stamped on the specification plate).
8. Ensure that all valves are switched off when not in use and being transported.
9. Take care not to spill fuel on the ground or in the tank at all times when filling TransCube or dispensing fuel.
10. Use on a level site.

To Fill Tank

1. Open filler cap slowly to relieve pressure (and vent cap if fitted), and fill with nozzle only. Do not hard connect.
2. Watch for level on gauge.
3. When full or adequate amount required (maximum 95% of capacity of tank), replace cap and tighten.
Note: Hand tighten fill cap and then tighten another 1/4 turn to minimize the chance of leakage.

Dispensing Fuel

1. Open outlet ball valve. Ensure dispensing nozzle is held while your pump is operating.
2. When finished, ensure nozzle and hose are replaced in pump cabinet, and ball valve, pump and nozzle are switched off.

If generator, feed and return lines are required, fit your choice of quick couplers to the designated points and pass hoses through the access slot on the sides of the cabinet so that it remains lockable. **It is important to use the correct filter to match your diesel engine.**

Note

These instructions apply to diesel fuel which is a hazardous material Packing Group III. If the IBC is to be used for anything other than diesel fuel, please check with the local authorities and check that the liquid falls within the Packing Group II or III and that the TransCube is labelled with the appropriate number on the UN placards. If the IBC is used for a flammable liquid, local fire regulations should be checked including the carrying of correct fire extinguishers.

MANUFACTURER LIMITED WARRANTY

This warranty is in substitution of every warranty as to quality fitness or description expressed or implied by statute, common law or custom.

WESTERN products are fully guaranteed for a period of one year from the date of purchase against faulty workmanship or material. Faulty products should be returned by the customer to the supplier. The supplier will replace or repair any faulty item free of charge, providing there is no obvious signs of abuse or indication that the equipment has not been used accordance with the Manual or instructions, and where maintenance is required this has been duly carried out. The above warranty covers only components made by us. Any components that are not of our manufacture are covered by the original manufacturer's guarantee.

Pump, hose and nozzle are subject to a three month warranty from date of supply.

WARRANTY DOES NOT COVER: wear and tear caused by normal use, damage caused by accident, abuse, off road use, faulty installation, misapplication, improper maintenance, violations of product manuals, warnings, misuse of operation instructions or Acts of God.

UNDER NO CIRCUMSTANCE can WESTERN be liable for any charges in respect of labour, indirect losses, consequential damage, loss of profit, loss of product, inability from use of product for any purpose whatsoever and all such fees and litigation.

WESTERN cannot be held liable for any misinterpretation of information given in this book. Further information as to the transport of diesel on USA roads should be obtained by a Transport or Dangerous Goods Advisor.

**WARRANTY VOID IF NOT REGISTERED
WITHIN 30 DAYS OF PURCHASE DATE.**

SERIAL NUMBER LOCATION

Always give your dealer the serial number of your Western Environmental TransCube when ordering parts or requesting service or other information.

The serial number plate is located where indicated. Please mark the number in the space provided for easy reference.

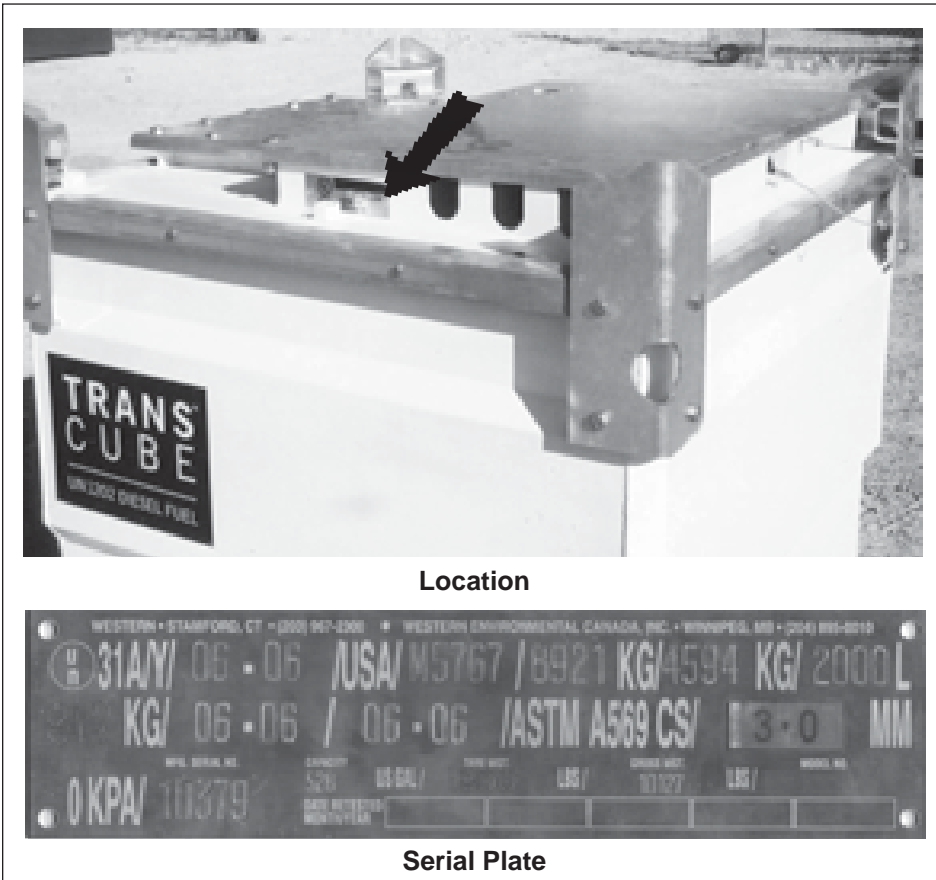

Model Number _____

Serial Number _____

TABLE OF CONTENTS

SECTION	DESCRIPTION
1	Introduction 1
2	Safety 2
2.1	General Safety..... 3
2.2	Equipment Safety Guidelines 4
2.3	Safety Training..... 5
2.4	Safety Signs 5
2.5	Preparation 6
2.6	Operating Safety..... 6
2.7	Storage Safety 6
2.8	Transport Safety 7
2.9	Maintenance Safety 7
2.10	Sign-Off Form 8
3	Safety Sign Locations 9
4	Operation..... 10
4.1	To the New Operator or Owner..... 10
4.2	Machine Components.....11
4.3	Machine Break-In 12
4.4	Pre-Operation Checklist 12
4.5	Controls 13
4.6	Field Use 15
4.7	Cleaning 28
5	Record Form 29
6	Trouble Shooting 31
7	Specifications 32
7.1	Mechanical 32
7.2	Bolt Torque..... 33
7.3	Hydraulic Fitting Torque 34
8	Index 35

1 INTRODUCTION

Congratulations on your choice of a TransCube to complement your refueling or transporting operation. This equipment has been designed and manufactured to meet the needs of a discriminating buyer for efficient refueling of equipment or transporting of fuel.

Safe, efficient and trouble free operation of your TransCube requires that you and anyone else who will be using or maintaining the tank, read and understand the Safety, Operation, Maintenance and Trouble Shooting information contained within the Operator's Manual.

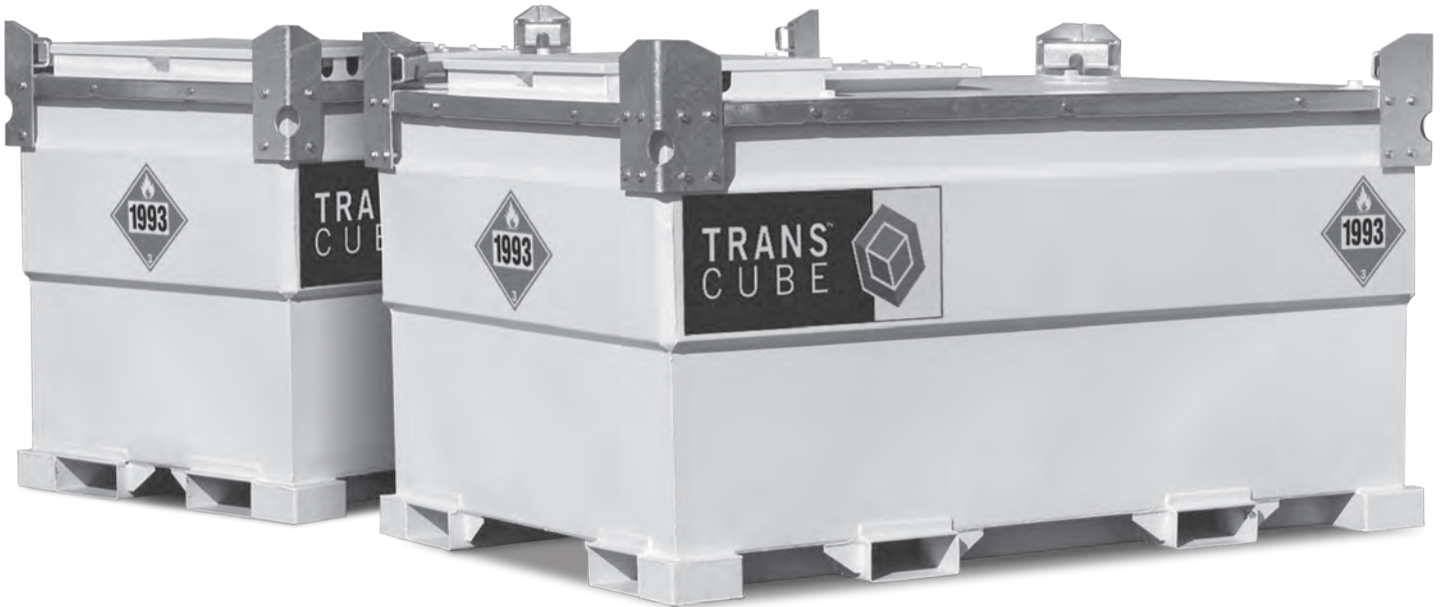

This manual covers the TransCube Models 05TCG, 10TCG, 20TCG, 30TCG and 50TCG. Use the Table of Contents or Index as a guide to locate required information.

Keep this manual handy for frequent reference and to pass on to new operators or owners. Call your dealer or the factory if you need assistance, information or additional copies of the manuals.

A document shelf is installed on the inside of the lid on most models for keeping the manual and records with the TransCube.

OPERATOR ORIENTATION - The directions left, right, front and rear, as mentioned throughout this manual, are as seen from the open cover and looking toward the unit.

2 SAFETY

SAFETY ALERT SYMBOL

This Safety Alert symbol means **ATTENTION! BECOME ALERT! YOUR SAFETY IS INVOLVED!**



The Safety Alert symbol identifies important safety messages on the TransCube and in the manual. When you see this symbol, be alert to the possibility of personal injury or death. Follow the instructions in the safety message.

Why is SAFETY important to you?

3 Big Reasons

Accidents Disable and Kill
Accidents Cost
Accidents Can Be Avoided

SIGNAL WORDS:

Note the use of the signal words **DANGER**, **WARNING** and **CAUTION** with the safety messages. The appropriate signal word for each message has been selected using the following guide-lines:

DANGER - Indicates an imminently hazardous situation that, if not avoided, will result in death or serious injury. This signal word is to be limited to the most extreme situations typically for machine components which, for functional purposes, cannot be guarded.

WARNING - Indicates a potentially hazardous situation that, if not avoided, could result in death or serious injury, and includes hazards that are exposed when guards are removed. It may also be used to alert against unsafe practices.

CAUTION - Indicates a potentially hazardous situation that, if not avoided, may result in minor or moderate injury. It may also be used to alert against unsafe practices.

If you have any questions not answered in this manual or require additional copies or the manual is damaged, please contact your dealer or Western, 18 Lois Street, Norwalk CT, 06851, Phone: (203) 847-4300, Fax: (203) 847-4310, Toll Free: 1-866-814-2470.

SAFETY

YOU are responsible for the SAFE operation and maintenance of your TransCube. **YOU** must ensure that you and anyone else who is going to use, maintain or work around the TransCube be familiar with the using and maintenance procedures and related **SAFETY** information contained in this manual. This manual will take you step-by-step through your working day and alerts you to all good safety practices that should be used while using the TransCube.

Remember, **YOU** are the key to safety. Good safety practices not only protect you but also the people around you. Make these practices a working part of your safety program. Be certain that **EVERYONE** using this equipment is familiar with the recommended using and maintenance procedures and follows all the safety precautions. Most accidents can be prevented. Do not risk injury or death by ignoring good safety practices.

- TransCube owners must give instructions to operators or employees before allowing them to use the tank, and at least annually thereafter per OSHA (Occupational Safety and Health Administration) regulation 1928.57.
- The most important safety device on this equipment is a SAFE operator. It is the operator's responsibility to read and understand ALL Safety and Using instructions in the manual and to follow these. Most accidents can be avoided.
- A person who has not read and understood all using and safety instructions is not qualified to use the machine. An untrained operator exposes himself and bystanders to possible serious injury or death.
- Do not modify the equipment in any way. Unauthorized modification may impair the function and/or safety and could affect the life of the equipment.
- Think SAFETY! Work SAFELY!

2.1 GENERAL SAFETY

1. Read and understand the Operator's Manual and all safety signs before using, maintaining, adjusting or cleaning the TransCube.



2. Have a first-aid kit available for use should the need arise and know how to use it.



3. Have a fire extinguisher available for use should the need arise and know how to use it.

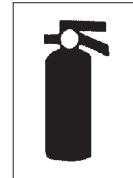

4. Wear appropriate protective gear. This list includes but is not limited to:

- A hard hat
- Protective shoes with slip resistant soles
- Protective glasses, goggles or face shield
- Heavy gloves
- Protective clothing



5. Install and secure all guards before starting.
6. Do not allow riders.
7. Do not smoke when refueling. Keep sparks, flames and hot material away from fuel and TransCube.



8. Place all controls in neutral, disconnect power source to pump and wait for all moving parts to stop before servicing, adjusting, repairing or cleaning.
9. Clear the area of people, especially small children, before using the unit.
10. Review safety related items annually with all personnel who will using or maintaining the TransCube.

2.2 EQUIPMENT SAFETY GUIDELINES

1. Safety of the operator and bystanders is one of the main concerns in designing and developing a machine. However, every year many accidents occur which could have been avoided by a few seconds of thought and a more careful approach to handling equipment. You, the operator, can avoid many accidents by observing the following precautions in this section. To avoid personal injury or death, study the following precautions and insist those working with you, or for you, follow them.
2. In order to provide a better view, certain photographs or illustrations in this manual may show an assembly with a safety shield removed. However, equipment should never be used in this condition. Keep all shields in place. If shield removal becomes necessary for repairs, replace the shield prior to use.
3. Replace any safety sign or instruction sign that is not readable or is missing. Location of such safety signs is indicated in this manual.
4. Never use alcoholic beverages or drugs which can hinder alertness or coordination while using this equipment. Consult your doctor about using this machine while taking prescription medications.
5. **Under no circumstances should young children be allowed to work with this equipment. Do not allow persons to use or assemble this unit until they have read this manual and have developed a thorough understanding of the safety precautions and of how it works.** Review the safety instructions with all users annually.
6. This equipment is dangerous to children and persons unfamiliar with its operation. The operator should be a responsible, properly trained and physically able person familiar with refueling machinery and trained in this equipment's operations. If the elderly are assisting with work, their physical limitations need to be recognized and accommodated.
7. Keep all flames, sparks or smoking material away from TransCube and working area. Do not smoke around unit.
8. Never exceed the limits of a piece of machinery. If its ability to do a job, or to do so safely, is in question - **DON'T TRY IT.**
9. Do not modify the equipment in any way. Unauthorized modification may result in serious injury or death and may impair the function and life of the equipment.
10. In addition to the design and configuration of this implement, including Safety Signs and Safety Equipment, hazard control and accident prevention are dependent upon the awareness, concern, prudence, and proper training of personnel involved in the operation, transport, maintenance, and storage of the machine. Refer also to Safety Messages and operation instruction in each of the appropriate sections of the machine Manuals. Pay close attention to the Safety Signs affixed to the equipment.
11. It is a serious offence to contaminate the ground or any water supply with spilt fuel. Care must be taken when filling TransCube or refueling equipment from the TransCube. Stay and monitor fuel transfers to prevent overfilling or spilling fuel on the ground or in the interstice.

2.3 SAFETY TRAINING

1. Safety is a primary concern in the design and manufacture of our products. Unfortunately, our efforts to provide safe equipment can be wiped out by a single careless act of an operator or bystander.
2. In addition to the design and configuration of equipment, hazard control and accident prevention are dependent upon the awareness, concern, prudence and proper training of personnel involved in the operation, transport, maintenance and storage of this equipment.
3. It has been said, "The best safety feature is an informed, careful operator." We ask you to be that kind of an operator. It is the operator's responsibility to read and understand ALL Safety and Using instructions in the manual and to follow these. Accidents can be avoided.An illustration showing a pair of hands holding an open book, symbolizing reading and learning.
4. Working with unfamiliar equipment can lead to careless injuries. Read this manual before assembly or using, to acquaint yourself with the machine. If this machine is used by any person other than yourself, or is loaned or rented, it is the machine owner's responsibility to make certain that the operator, prior to using:
 - a. Reads and understands the operator's manuals.
 - b. Is instructed in safe and proper use.
5. Know your controls and how to stop unit quickly in an emergency. Read this manual and the one provided with your equipment.
6. Train all new personnel and review instructions frequently with existing workers. Be certain only a properly trained and physically able person will use the machinery. A person who has not read and understood all using and safety instructions is not qualified to use the machine. An untrained operator exposes himself and bystanders to possible serious injury or death. If the elderly are assisting with the work, their physical limitations need to be recognized and accommodated.

2.4 SAFETY SIGNS

1. Keep safety signs clean and legible at all times.
2. Replace safety signs that are missing or have become illegible.
3. Replaced parts that displayed a safety sign should also display the current sign.
4. Safety signs displayed in Section 3 each have a part number in the lower right hand corner. Use this part number when ordering replacement parts.
5. Safety signs are available from your authorized Distributor or Dealer Parts Department or the factory.

How to Install Safety Signs:

- Be sure that the installation area is clean and dry.
- Be sure temperature is above 50°F (10°C).
- Determine exact position before you remove the backing paper. (See Section 3).
- Remove the smallest portion of the split backing paper.
- Align the sign over the specified area and carefully press the small portion with the exposed sticky backing in place.
- Slowly peel back the remaining paper and carefully smooth the remaining portion of the sign in place.
- Small air pockets can be pierced with a pin and smoothed out using the piece of sign backing paper.

2.5 PREPARATION

1. Never use the unit until you have read and completely understand this manual and each of the Safety Messages found on the safety signs on the unit.

2. Personal protection equipment including hard hat, safety glasses, safety shoes, and gloves are recommended during assembly, installation, operation, adjustment, maintaining, repairing, removal, cleaning, or moving the unit. Do not allow long hair, loose fitting clothing or jewelry to be around equipment.



3. **PROLONGED EXPOSURE TO LOUD NOISE MAY CAUSE PERMANENT HEARING LOSS!**

Power equipment with or without equipment attached can often be noisy enough to cause permanent, partial hearing loss. We recommend that you wear hearing protection on a full-time basis if the noise in the Operator's position exceeds 80db. Noise over 85db on a long-term basis can cause severe hearing loss. Noise over 90db adjacent to the Operator over a long-term basis may cause permanent, total hearing loss. **NOTE:** Hearing loss from loud noise (from tractors, chain saws, radios, and other such sources close to the ear) is cumulative over a lifetime without hope of natural recovery.



4. Use only in daylight or good artificial light.
5. Be sure machine is properly mounted, adjusted and in good using condition.
6. Ensure that all safety shielding and safety signs are properly installed and in good condition.

2.6 OPERATING SAFETY

1. Please remember it is important that you read and heed the safety signs on the TransCube. Clean or replace all safety signs if they cannot be clearly read and understood. They are there for your safety, as well as the safety of others. The safe use of this tank is strictly up to you, the operator.
2. Use only for the transport of diesel fuel for refueling equipment or stand-by generators.
3. Keep the tank level when filling.
4. Fill only with a hand-held trigger nozzle. Take care not to spill any fuel on the ground or in the interstice.
5. Do not smoke when refueling. Keep sparks, flames and hot material away from fuel and TransCube.
6. Do not over fill. 95% is the maximum legal limit.
7. Always replace filler cap and turn pump off (lever down) when refueling finished.
8. Store diesel hose and nozzle inside outer tank.
9. Close all valve outlets and lock lid when transporting on public highway.
10. Follow the regulations for transport of Dangerous Goods.
11. Check for fluid in outer tank and empty regularly - refer to maintenance manual for detailed procedure.



2.7 STORAGE SAFETY

1. Store the unit in an area away from human activity.
2. Do not permit children to play on or around the stored machine.
3. Store the unit in a dry, level area. Support the frame with planks if required.
4. Disconnect all power connections and close all valves before storing.

2.8 TRANSPORT SAFETY

1. Read and follow the Operator's Manual before using the TransCube.
2. Review and follow the User's Notice inside the lid before using.
3. Be familiar with the requirements of "Transport of Dangerous Goods" regulations and follow them.
4. Train all drivers about the requirements of transporting an Intermediate Bulk Container (IBC). Do not allow untrained personnel to drive.
5. Be sure each driver has the appropriate drivers licence required by the Federal, Provincial/State or local authorities.
6. Keep shipping papers describing tank and contents with vehicle at all times.
7. Keep current Test Record Card with tank at all times.
8. Keep Transport of Dangerous Goods (TDG) Regulation Placard with the appropriate UN number on each of the vertical sides when transporting. Cover placards when tank is empty and purged.
9. Securely anchor tank to truck with bolts before transporting.
10. Turn off pump (move lever down) and close generator port valves.
11. Be sure filler cap is on and closed securely.
12. Be sure all outlets are securely closed/plugged with plugs provided by the manufacturer.
13. Ensure outer tank is empty of spillage.
14. Close and padlock hatch to prevent vibration releasing the catch.

2.9 MAINTENANCE SAFETY

1. Good maintenance is your responsibility. Poor maintenance is an invitation to trouble.
2. Follow good shop practices.

- Keep service area clean and dry.
- Be sure electrical outlets and tools are properly grounded.
- Use adequate light for the job at hand.



3. Make sure there is plenty of ventilation. Never use the engine of the transport vehicle in a closed building. The exhaust fumes may cause asphyxiation.
4. Before working on this machine. Disconnect the power to the pump and close all valves.
5. Do not smoke when performing any maintenance work. Keep sparks, open flames and hot material away from work site.
6. Always use personal protection devices such as eye, hand and hearing protectors, when performing any service or maintenance.
7. A fire extinguisher and first aid kit should be kept readily accessible while performing maintenance on this equipment.
8. Periodically tighten all bolts, nuts and screws and check that all electrical connections are properly secured to ensure unit is in a safe condition.
9. When completing a maintenance or service function, make sure all safety shields and devices are installed before placing unit in service.
10. Establish a lock-out tag-out policy for the work site. Be sure all personnel are trained in and follow all procedures.

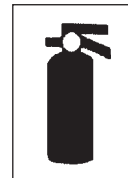

2.10 SIGN-OFF FORM

The equipment provider follows the general Safety Standards specified by the UN/DOT for the transport of diesel fuel. Anyone who will be using and/or maintaining the tank must read and clearly understand ALL Safety, Usage and Maintenance information presented in this manual.

Do not use or allow anyone else to use this tank until such information has been reviewed. Annually review this information before the season start-up.

Make these periodic reviews of SAFETY and OPERATION a standard practice for all of your equipment. We feel that an untrained operator is unqualified to use this machine.

A sign-off sheet is provided for your record keeping to show that all personnel who will be working with the equipment have read and understand the information in the Operator's Manual and have been instructed in the operation of the equipment.

SIGN-OFF FORM

DATE	EMPLOYEES SIGNATURE	EMPLOYERS SIGNATURE

3 SAFETY SIGN LOCATIONS

The types of safety signs and locations on the equipment are shown in the illustrations that follow. Good safety requires that you familiarize yourself with the various safety signs, the type of warning and the area, or particular function related to that area, that requires your SAFETY AWARENESS.

- Think SAFETY! Work SAFELY!

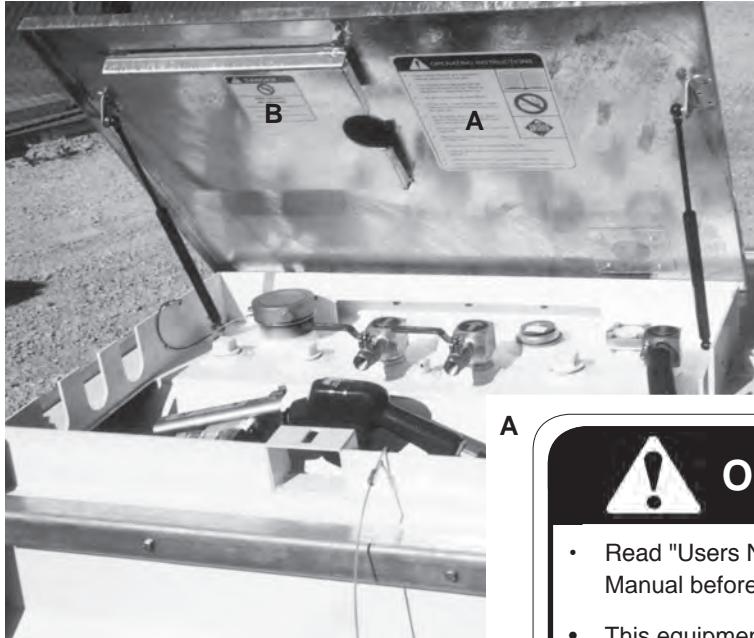

A

OPERATING INSTRUCTIONS

- Read "Users Notice" and Operator's Manual before using fuel tank.
- This equipment is designed for the transport of diesel fuel, for refueling equipment or generator stand-by.
- The tank must be level while filling.
- Fill only with a hand held trigger nozzle. Take care not to spill on the ground or in the tank.
- Do not smoke when refueling. Keep sparks, flames and hot material away from fuel and fuel tank.
- Do not overfill. 95% capacity is maximum legal limit.
- Always replace filler cap and turn pump off (lever down).
- Store diesel hose and nozzle inside outer tank.
- Close all valve outlets and lock lid when transporting on public highway.
- Follow the regulations for Transport of Dangerous Goods.
- Check for fluid in outer tank and empty regularly - refer to maintenance manual for detailed procedure.

TC0206

B

DANGER

FIRE HAZARD
NO SMOKING

To prevent serious injury or death from fire:

- Do not smoke when refueling.
- Keep sparks, flames and hot material away from fuel and TransCube.

TC0207

REMEMBER - If safety signs have been damaged, removed, become illegible or parts replaced without safety signs, new signs must be applied. New safety signs are available from your authorized dealer.

4 OPERATION



OPERATING SAFETY

- Please remember it is important that you read and heed the safety signs on the TransCube. Clean or replace all safety signs if they cannot be clearly read and understood. They are there for your safety, as well as the safety of others. The safe use of this tank is strictly up to you, the operator.
- Use only for the transport of diesel fuel for refueling equipment or stand-by generators.
- Keep the tank level when filling.
- Fill only with a hand-held trigger nozzle.
- Do not spill fuel on the ground or in the tank.
- Do not smoke when refueling. Keep sparks, flames and hot material away from fuel and TransCube.
- Do not over fill. 95% is the maximum legal limit.
- Always replace filler cap and turn pump off (lever down) when refueling finished.
- Store diesel hose and nozzle inside outer tank.
- Close all valve outlets and lock lid when transporting on public highway.
- Follow the regulations of the Transport of Dangerous Goods.
- Check for fluid in outer tank and empty regularly - refer to maintenance manual for detailed procedure.

4.1 TO THE NEW OPERATOR OR OWNER

The TransCube is a double-walled steel tank with baffles and an electric pump for transferring diesel fuel. It was tested and certified to UN requirements and is legal to use in Canada and the U.S. Be familiar with the machine before starting.

It is the responsibility of the owner or operator to read this manual and to train all other operators before they start working with the machine. Follow all safety instructions exactly. Safety is everyone's business. By following recommended procedures, a safe working environment is provided for the operator, bystanders and the area around the worksite. Untrained operators are not qualified to use the machine.

In addition to the design and configuration of equipment, hazard control and accident prevention are dependent upon the awareness, concern, prudence and proper training of personnel involved in the operation, transport, maintenance and storage of equipment. It is the responsibility of the owner or operator to read this manual and to train all other operators before they start working with the machine.

Many features incorporated into this machine are the result of suggestions made by customers like you. Read this manual carefully to learn how to use the tank safely and how to set it to provide maximum field efficiency. By following the using instructions in conjunction with a good maintenance program, your TransCube will provide many years of trouble-free service.

4.2 MACHINE COMPONENTS

The TransCube is a double-walled tank for holding, transferring or transporting fuel. The fuel tank mounts inside the outer tank. The TransCube is designed so the outer tank is large enough to hold all the fluid should the inner fuel tank break, crack or leak (110% capacity in the interstice).

Close and lock the lid when transporting or not using the tank. The 3 inch fill plug is located on the inner tank along with the 3 psi fusible plug for venting. A fuel gauge is mounted next to the fill plug to assist in filling the tank.

An electric pump, hose and hand-held nozzle are used to transfer fuel and the nozzle hooks to the side frame. Power must be supplied by the customer to power the pump. Output and return line with valves can be connected to an engine operating at a remote location. The outer tank is designed with an access hole for routing fuel lines if required for your application.

An optional volume meter can be mounted under the lid to measure the amount of fuel being dispensed. TDG placards are located on each side of the tank.

- A Outer Tank (with removable lid)
- B Inner Tank
- C Hatch Lid
- D Filler Cap (3")
- E Fuel Gauge
- F Electric Pump
- G Pump ON/OFF
- H Fuel Feed Line/Valve
- J Fuel Return Line/Valve
- K Refueling Hose
- L Nozzle
- M Nozzle Storage Bracket
- N Manhole Cover
- O Relief Vent
- P Optional Fuel Meter
- Q TDG Placards
- R Power Cord
- S Tie down point
- T Stacking Brackets
- W Fuel Line Access Slots
- X Lifting bracket



Fig. 1 PRINCIPLE COMPONENTS

4.3 MACHINE BREAK-IN

Although there are no operational restrictions on the TransCube when used for the first time, it is recommended that the following mechanical items be checked:

A. After Using for 1 and 5 Hours:

1. Check all nuts, bolts and other fasteners. Tighten to their specified torque level.
2. Check that the fuel lines and connections are in good condition and there are no leaks.
3. Check that the electrical system is in good condition. Be sure all terminals and connectors are clean and fully engaged.
4. Then go to the regular service schedule as defined in Section 5.

4.4 PRE-OPERATION CHECKLIST

Efficient and safe operation of the TransCube requires that each operator reads and understands the using procedures and all related safety precautions outlined in this section. A pre-operation checklist is provided for the operator. It is important for both the personal safety and maintaining the good mechanical condition of the TransCube that this checklist is followed.

Before using the TransCube and each time thereafter, the following areas should be checked off:

1. Check that the TransCube is bolted or anchored to the transporting vehicle.
2. Disconnect and secure all the lines and hoses before transporting.
3. Close and tighten filler cap when tank is full.
4. Turn pump off and disconnect or remove power lines.
5. Check the interstice area (bund). Clean if there is any debris, trash or diesel fuel.
6. Check that all the required documentation and placards are with the unit and in good condition.

4.5 CONTROLS

The TransCube is designed and built with components that allow for easy and convenient transporting, filling and transferring fuel. Each operator should be trained in TransCube operation before using and the controls on the unit. They must also be required to know all the legal and regulatory regulations relating to the transporting and handling of fuel.

Review the controls on the unit prior to using and as a part of the regular training program:

1. **Pump ON/OFF:**

This lever controls the power to the transfer pump on the top of the tank. Move the lever up to turn the pump ON and down to turn OFF.

2. **Nozzle:**

NOTE

The power cord must be connected or attached to a power source for the pump to run.

NOTE

Depress the trigger on the hand-held nozzle when transferring fuel.

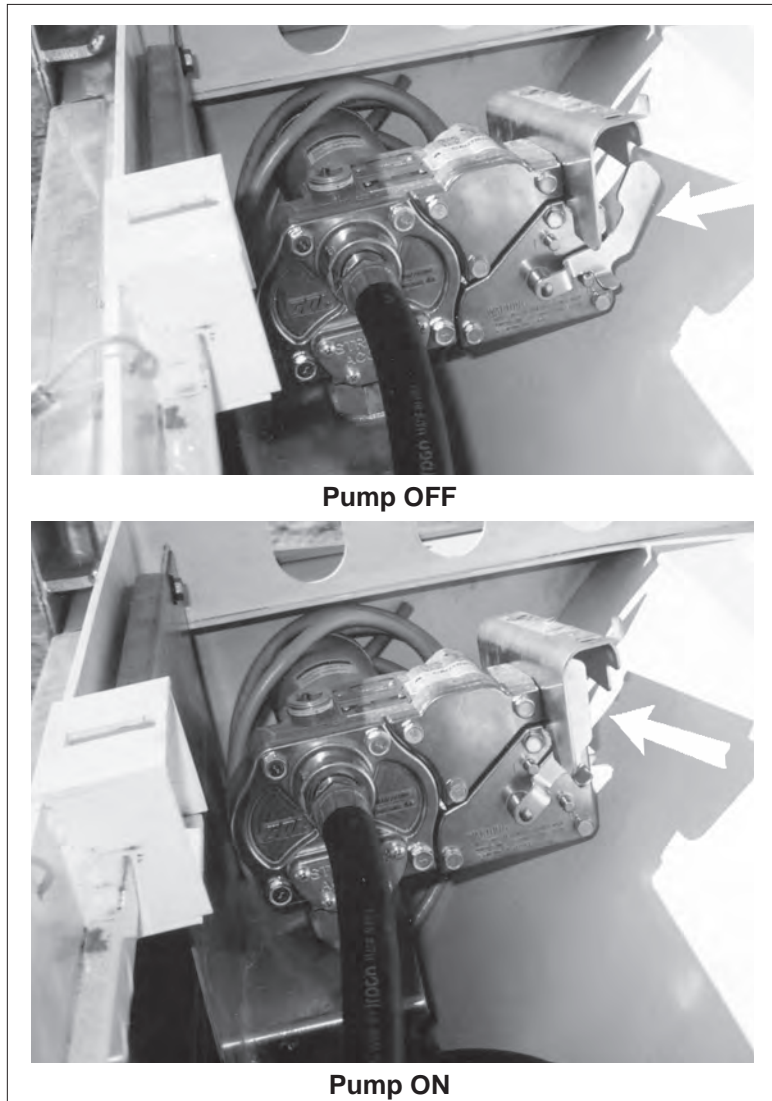

Fig. 2 UNDER LID

This hand-held nozzle is used to transfer fuel. Depress the trigger on the nozzle to transfer fuel. The pump must be connected to a power supply and turned on before transferring fuel.

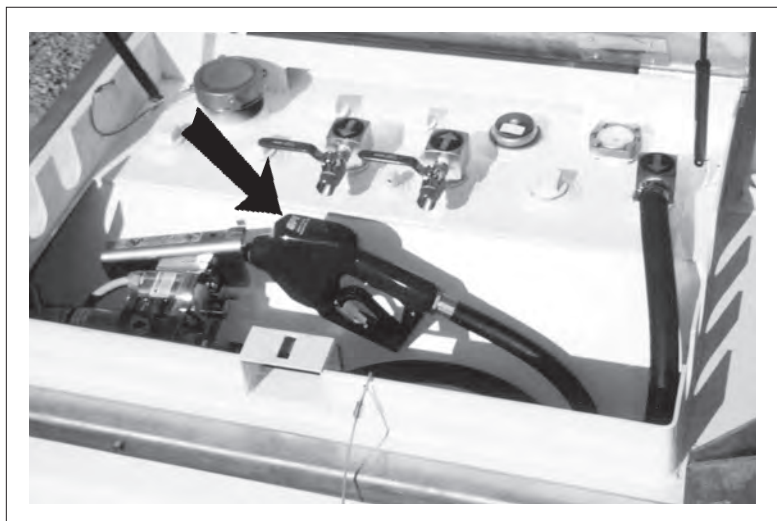

Fig. 3 NOZZLE

3. **Fuel Gauge:**

This gauge shows the amount of fuel in the tank. Watch this gauge when filling the tank. Do not fill more than 95% to prevent spillage and allow for expansion.

4. **Fuel Meter (Optional):**

This meter measures the volume of fuel being transferred by the hose and nozzle. Depress the reset button on top to zero the gauge when required.

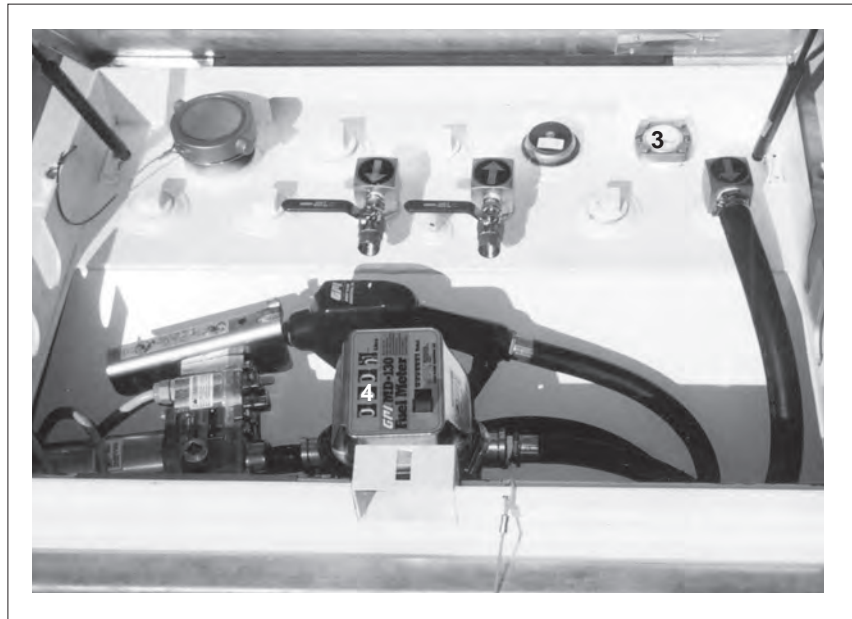

Fig. 4 FUEL METER (OPTIONAL)

5. **Shut-Off Valves:**

The TransCube is designed with a line for drawing fuel out of the tank and a line for returning the unused fuel from the remote engine. Turn the valve handle at right angles to the line to turn the valves off. Align with the line to open the valve. Always turn the valves off when not using the lines or when moving the unit.

6. **Optional Outlets:**

The TransCube is designed with additional outlets that can be used to connect to additional feed lines.

Always mount shut-off valves to the lines when connecting to new feed lines.

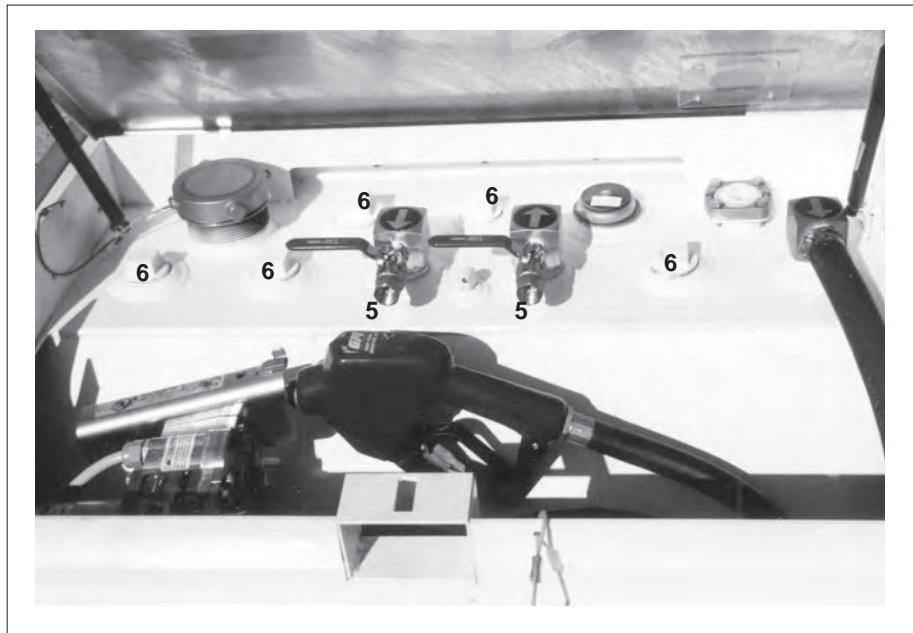

Fig. 5 INSIDE COVER

4.6 FIELD USE



OPERATING SAFETY

- Please remember it is important that you read and heed the safety signs on the TransCube. Clean or replace all safety signs if they cannot be clearly read and understood. They are there for your safety, as well as the safety of others. The safe use of this tank is strictly up to you, the operator.
- Use only for the transport of diesel fuel for refueling equipment or stand-by generators.
- Keep the tank level when filling.
- Fill only with a hand-held trigger nozzle.
- Do not spill fuel on the ground or in the tank.
- Do not smoke when refueling. Keep sparks, flames and hot material away from fuel and TransCube.
- Do not over fill. 95% is the maximum legal limit.
- Always replace filler cap and turn pump off (lever down) when refueling finished.
- Store diesel hose and nozzle inside outer tank.
- Close all valve outlets and lock lid when transporting on public highway.
- Follow the regulations of the Transport of Dangerous Goods.
- Check for fluid in outer tank and empty regularly - refer to maintenance manual for detailed procedure.

The TransCube is designed to efficiently and effectively transfer, transport and refuel equipment in any location. It meets and exceeds all Canadian and U.S. DOT fuel transporting requirements and has UN certification. These IBC's are built to U.S. Standard Code of Federal Regulations (CFR) part 49 and are updated by annual tests. Max in USA 793 gallons.

Each owner and user of the TransCube should review this manual as part of the regular training and review procedure. Follow all instructions.

1. **Owner/Operator Responsibility:**

It is the responsibility of each owner, operator or user to be familiar with all regulations that apply to the equipment for transporting, filling, transferring and refueling equipment. Perform all tests per the regulations and maintain the appropriate records and paperwork. Always carry the required paperwork for the Transport of Dangerous Goods. Be sure everyone is properly trained and licensed to use or transport the TransCube. Do not smoke around unit. Do not allow others to smoke around unit.

2. Venting:

- a. Each tank is designed with a stainless steel and polyethylene pressure/vacuum relief vent with elastomer seals set at 3 psi. Maintain in good condition. Replace vent if damaged in any way. Replace vent at the 60 month test.
- b. The fill cap is designed with a 3 inch NPS stainless steel fusible (viton) ring that would melt when the temperature reaches 250°F. Keep it in good condition. Replace cap if it is damaged in any way.
- c. The outer tank is vented to atmosphere through the hose slots under the lid. Do not obstruct in any way.

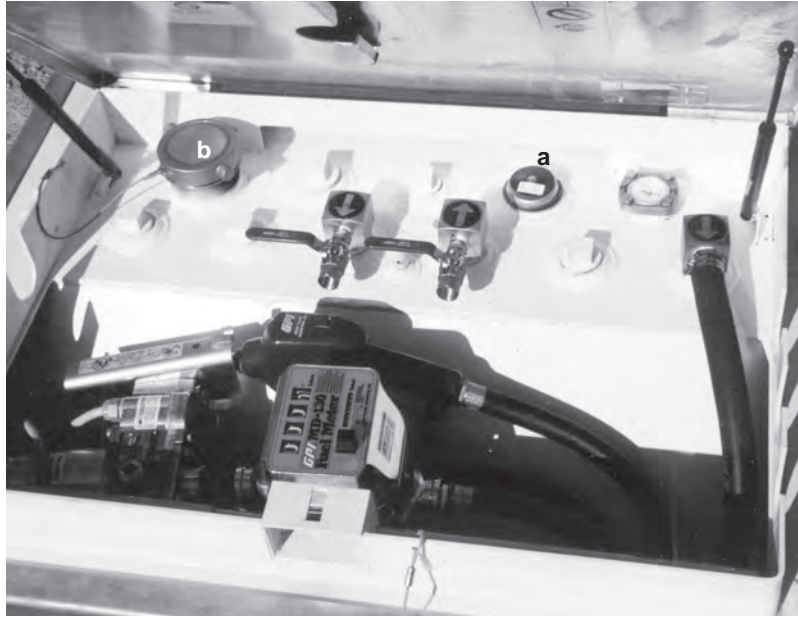

Inner

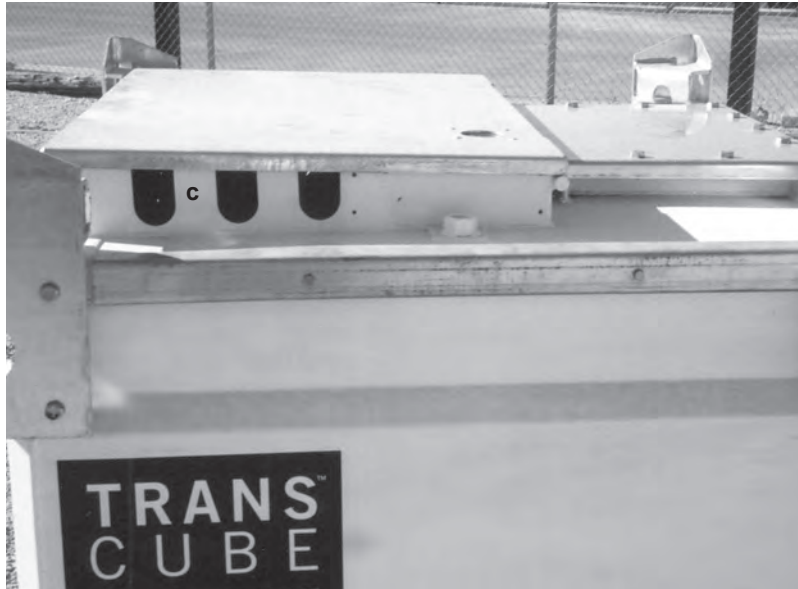

Outer

Fig. 6 LEVELING

3. **Securement for Transport:**

The frame is designed with brackets on the top corners to anchor the tie-downs when transporting. Do not transport TransCube unless it is securely tied-down to the vehicle frame.

The TransCube must be securely attached to its means of transport, be it a custom trailer, flat-bed trailer or skid.



Brackets

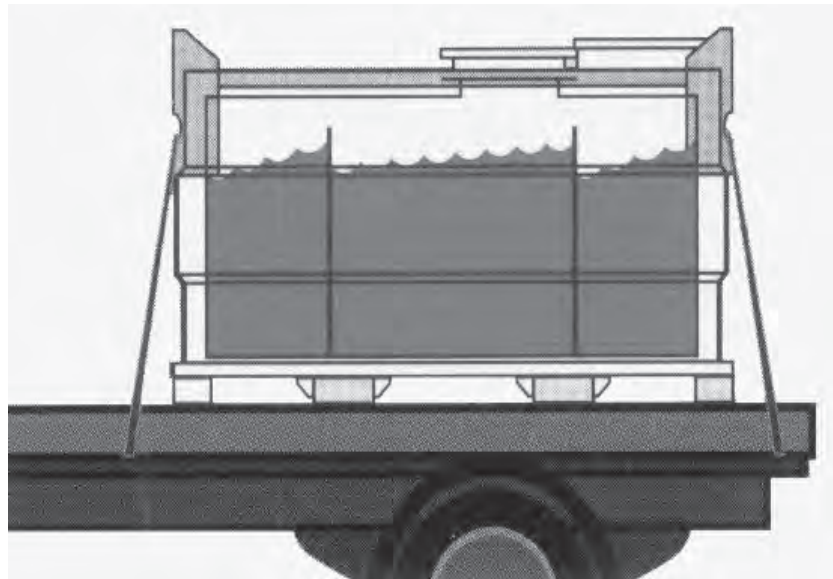

Schematic



Trailer

Fig. 7 MOUNTED ON CUSTOM TRAILER

4. **Filling TransCube:**

A 3 inch fill cap is located on the top of the tank and is used to fill the tank. Turn the cap to open the tank for filling. Open the cap slowly to release any build-up of pressure due to extreme temperatures. Close and tighten cap when filling is completed. Follow this procedure when filling tank:

- a. Level the tank or the vehicle that it is mounted on.
- b. Loosen fill cap and lay to the side.



Filling

NOTE

The cap is tethered to the frame with a steel cable to prevent it from falling between the tanks. Keep cable in good working condition. Do not disconnect.

- c. Fill the tank with a hand-held nozzle.

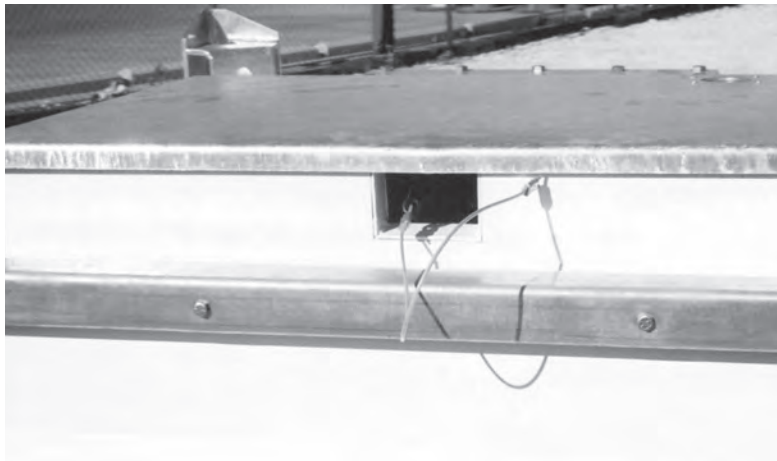

Hatch Lid Locked

IMPORTANT

Do not direct connect. Take care not to spill any fuel.

Fig. 8 FILLING

- d. Watch the fuel gauge on tank while filling to only fill to 95% capacity. 95% is the legal capacity for the TransCube.
- e. Close and tighten fill cap.

NOTE

Hand tighten fill cap and then tighten another 1/4 turn to minimize the chance of leakage.

- f. Close and lock the hatch lid.



5. **Closure for Transport:**

The TransCube must be securely closed prior to moving or transporting to minimize the chance of spilling fuel.

Follow this procedure when preparing for transport:

- a. Turn the pump off by moving the control lever down.

IMPORTANT

The closure systems nearest to the contents of the IBC should be closed first.

- b. Turn the generator port valves off.
- c. Close and tighten fill cap.
- d. Close or plug all auxiliary lines, hoses or other connectors with the plugs provided with the tank.
- e. Stow the hose and hand held nozzle under the cover.
- f. Close and lock hatch-lid on the outer tank.

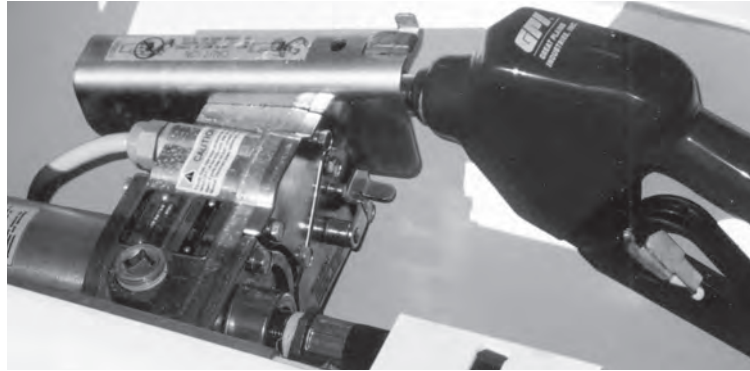

Pump Off



Nozzle Stowed



Trailer

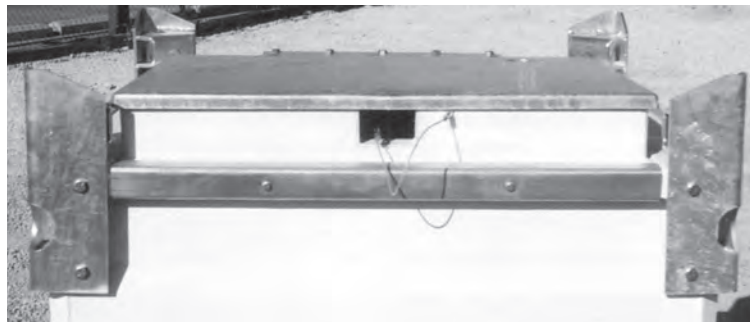

Lid Lock

Fig. 9 TRANSPORT

6. **Generator Standby:**

The TransCube is designed to be used to provide fuel to generator sets or any other power unit requiring fuel.

Follow this procedure when connecting as a fuel supply to an engine:

- a. Place TransCube in a level area adjacent to the engine requiring fuel.
- b. Install quick couplers into the tank outlets appropriate for your application. The feed or return ports are marked with directional arrows.

NOTE

Use teflon tape on the threads to prevent leaking at the connection.

- c. Use connector components with NPT threads.
- d. Thread the power unit fuel line hoses through the access slots on each side of the frame.
- e. Connect to the quick couplers on the tank outlets.

IMPORTANT

It is recommended that a fuel filter be installed in the intake line to remove any contaminants from the system prior to entering the engine fuel system.

- f. Open tank valves and start engine.
- g. Close and lock lid to prevent anyone from tampering with the fueling equipment.
- h. Check the fuel gauge and refill the tank when required to prevent running out.
- i. Turn valves off, disconnect power, disconnect couplers, and lock lid when TransCube is not being used.

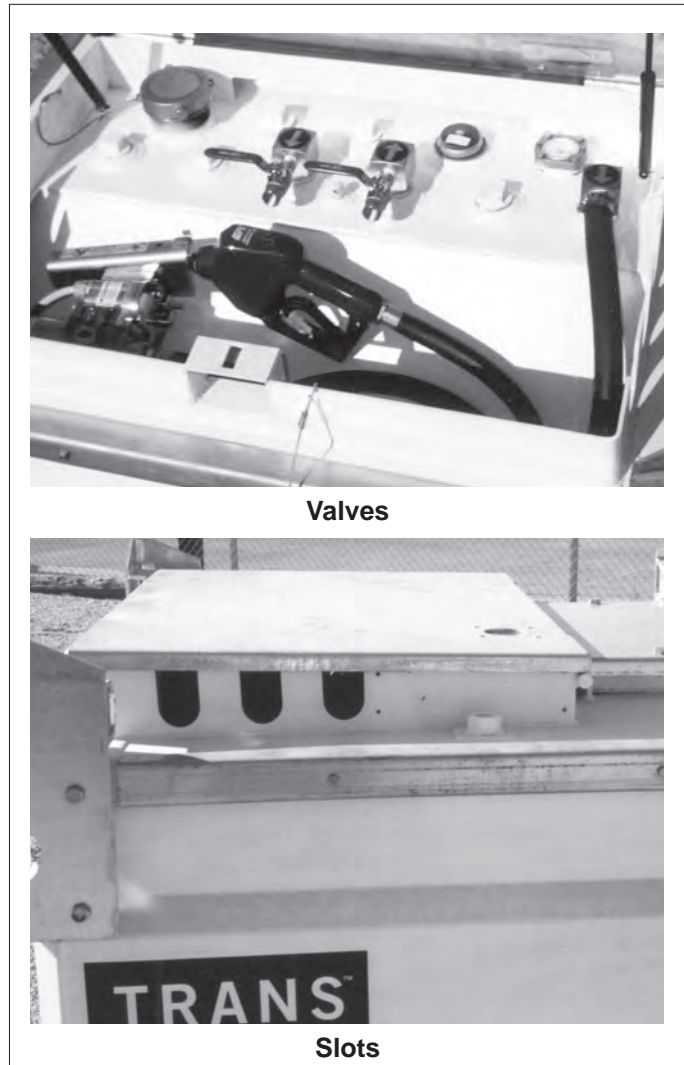

Fig. 10 FUEL LINES

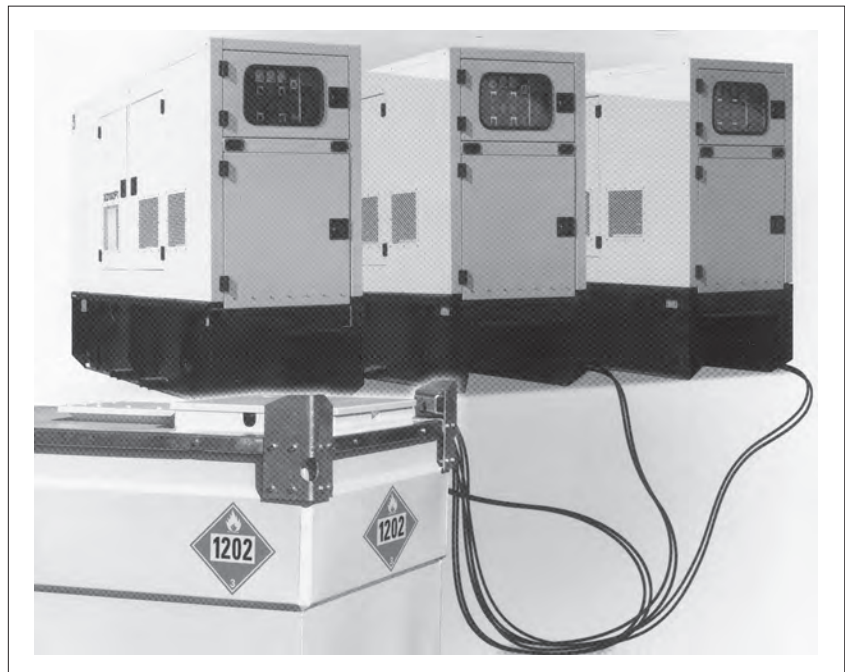

Fig. 11 SUPPLY FUEL

7. **Refueling:**

The TransCube works well as a tank to refuel other tanks, machines or equipment. Review the pump manual prior to using the pump. Follow this procedure when refueling:

- a. Refer to Step 4 (pg. 18) "Filling TransCube".
- b. Transport the TransCube to the refueling area.
- c. Unlock and open hatch lid.
- d. Pull out refueling hose and nozzle.
- e. Extend it to the tank needing to be refueled.
- f. Connect a power supply to the pump (minimum 20 amp rating).
- g. Turn the pump on.
- h. Use the hand-held nozzle to transfer the fuel.
- i. Turn the pump off when the refueling is completed.



Fig. 12 FILLING TANK

IMPORTANT

Do not spill fuel into the interstice (bund). Wipe up any spills.

- j. Disconnect the power to the pump.

NOTE

Use the optional fuel meter to monitor how much fuel is being transferred or use the fuel gauge.

- k. Store the hose into the bund and hook the nozzle to the storage bracket.
- l. Close and lock the hatch lid.
- m. Move to the next refueling location.

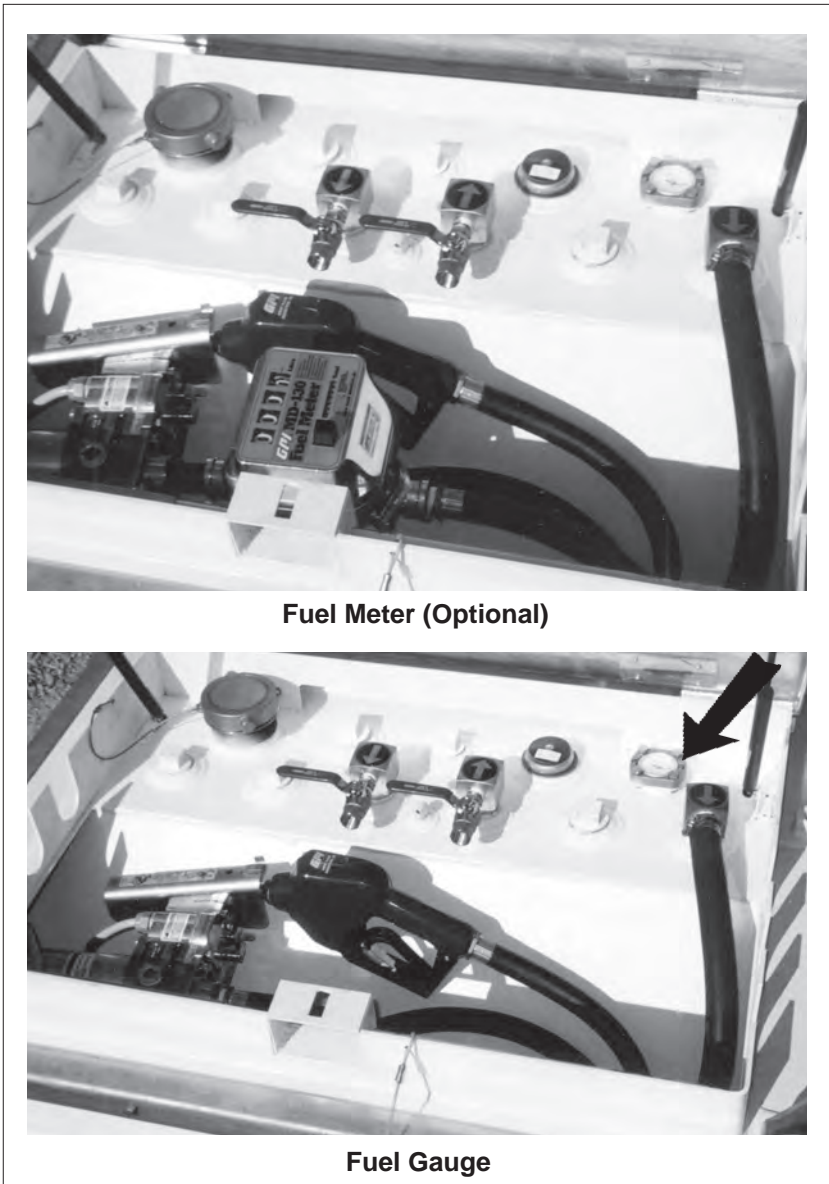

Fuel Meter (Optional)

Fuel Gauge

Fig. 13 COVER OPEN

8. **Fuel Gauge:**

The TransCube is designed with a gauge that displays the amount of fuel in the tank. Always watch the gage when filling the tank to prevent over-filling.

The lid is designed with an access hole above the gauge to allow for monitoring the fuel level without the need to open the lid.

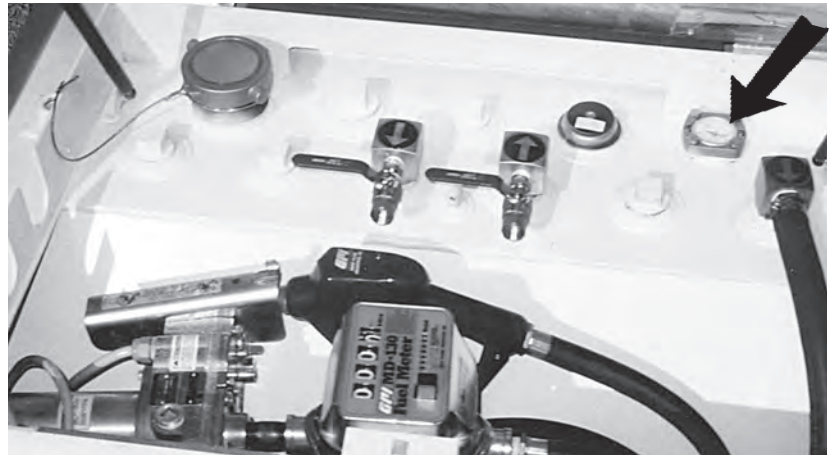

Gauge

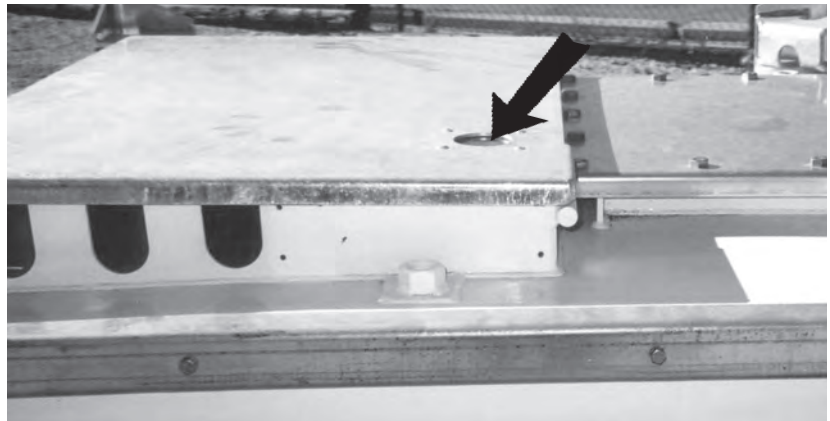

Access Hole

Fig. 14 FUEL GAUGE

9. **Forklifts:**

The base of the TransCube is designed with pockets on all sides to allow access for the forks of a forklift. A forklift can pick up the tank from any side when it is necessary to raise or maneuver the unit.



Fig. 15 FORKLIFT POCKETS

10. **Additional Outlets:**

The top of the tank is designed with extra outlets to allow additional engines or machines to use the tank as a source for fuel. Install the feed and return lines, down tube check valve, strainer and return port into the outlets. Mount shut-off valves to each line to allow the line to be turned off when required.

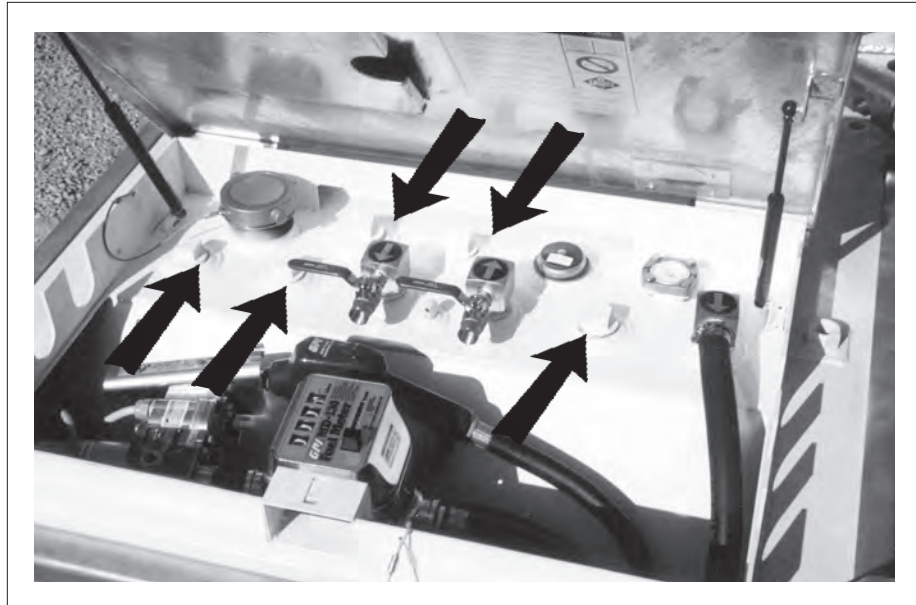

Fig. 16 ADDITIONAL OUTLETS

11. **Manway Access Cover:**

The top is designed with a cover to provide access to the inside of the tank when required. Remove the anchor bolts and cover when it is required to enter the tank. Always install a new gasket when re-installing cover.

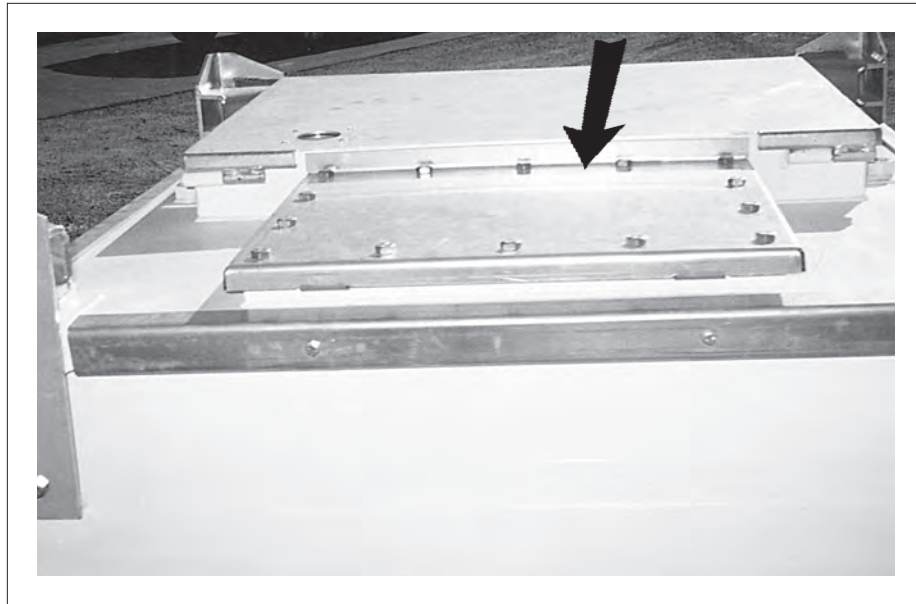

Fig. 17 MANWAY ACCESS COVER

12. Records:

- Each owner or operator is responsible to obtain records from the periodic inspections and re-testing of the IBC TransCube and keep them with the unit. Place your record and operator's manual in the vinyl sleeve provided on the shelf above the inner tank.
- Keep the records available with the unit and make them available to Government Representatives or Inspectors on site when requested.
- A Record Card is provided with the Documentation package to record the compulsory 60 month testing program at a registered facility. The date and test results must be recorded on the card and stamped on the Specification Plate.



Fig. 18 SLEEVE FOR DOCUMENTS

13. Damage:

- Anything that is transported from location to location can be in an accident and damaged or damaged during use. Any time the inner or outer tank is damaged, impaired or compromised in any way, the tanks should be repaired and then retested up to 3 psi.
- Diesel fuel is a hazardous material and must be treated as such. Do not use the unit if it is damaged and take a chance with contaminating your worksite or the environment. Repair and retest prior to re-using.

14. Parts and Service:

- Transport of Dangerous Goods requires that parts replacement must be of the same specification or equivalent. It is recommended that genuine replacement parts be obtained from Western Environmental Canada Inc. such as nitrile gaskets, fusible fill caps, pressure/vacuum relief vent and gauges.

Call 1-866-539-3781. Please have your model number, serial number of your TransCube model ready and the parts description. Do not return parts.

15. **Storage:**

- The frame of the TransCube is designed with the structural strength to allow stacking 2 high when full and 3 high when empty. Always mate the corner brackets together to stabilize the pile.
- Use only a hoist or forklift with the required lift capacity to raise, lower or stack the tanks.



Fig. 19 STORAGE AND HANDLING

16. Power Source:

- When a pump is fitted, the unit comes from the factory with a power cord to the pump. It is recommended that 20 amp rated battery clamps on the power cord to attach to battery terminals on the equipment being refueled (12 volt pump only).

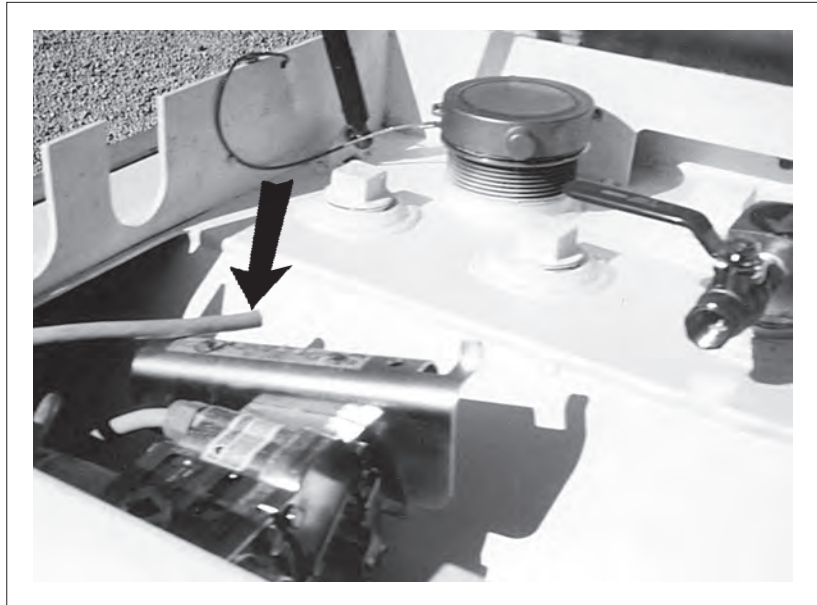

Fig. 20 POWER CORD

17. Monitoring:

The best results are obtained when the TransCube is monitored, inspected, checked and tested per this recommended list. Keep and maintain these records.

a. During Fuel Transfers:

Someone needs to be in attendance when filling the TransCube or transferring fuel. Always manually hold the nozzle and depress the trigger when transferring into or out of the TransCube. Visually monitor the fuel gauge while transferring fuel to prevent spilling or overfilling. Remember the maximum legal capacity is 95% full. Do not direct connect.

b. Daily Checklist (While In Use):

It is recommended that the tank and all of its components be maintained in good condition at all times. Develop a checklist to use when verifying the condition of each component or system. It should include but not be limited to:

- Fuel level.
- Pipes, tubes, valves and couplers.
- Hoses, nozzles and connections.
- Leaks.
- Bent, broken or damaged components.
- Electrical wires, terminals and connections.

Stop leaks, repair problems and replace any broken components with genuine replacement parts or their equivalent.

c. **Weekly and Before Transporting:**

- Visually check the interstice (bund) to verify that there have been no leaks from the primary tank or any spills during fuel transfers. If it has any sludge or liquid in it, hand pump it into an approved container, seal it and dispose of it in accordance with local regulations. Do not pour on the ground or put in drains.

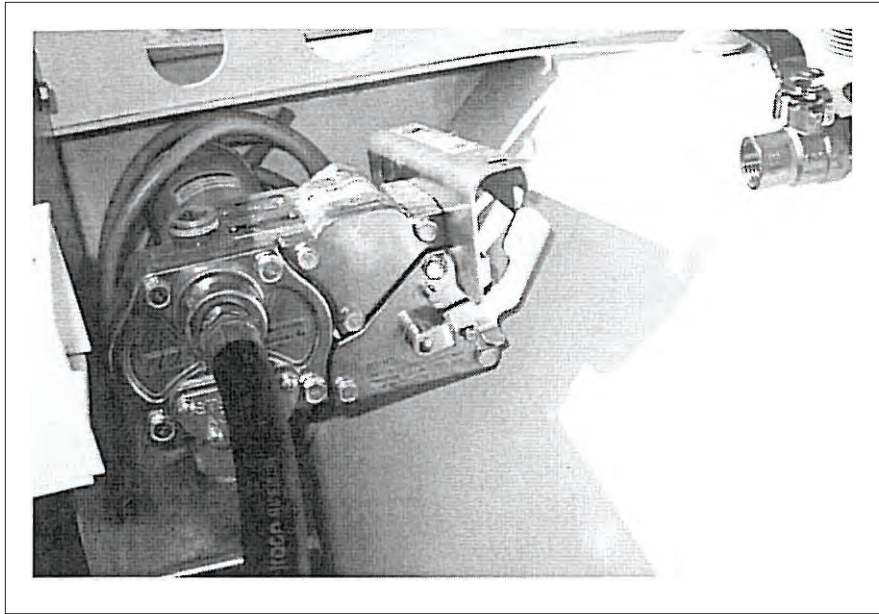

Fig. 21 INTERSTICE

- If severe sludge or trash formed in the interstice, it is recommended that the inner tank be removed and the outer tank be completely washed out. Do not take chances with contaminating the workplace or the environment.
- d. **Monthly:**
- Lubricate the door hinge and lock.
 - Clean out pump and line filters including strainer.
 - Visually check tank, hoses, valves, pump and other components for cracks, corrosion and leakage.
 - Correct all deficiencies before starting. Stop leaks. Make repairs using only genuine replacement parts or their equivalent.

e. **Compulsory 60 Month Testing at a Registered Facility:**

The Transport of Dangerous Goods requires IBC's to be leak proof tested and inspected internally and externally at a Government Registered Facility with the results being recorded on the Record Card and the date stamped on the Specification Plate.

18. **Preparation for 60 Month Testing:**

Cleaning - prior to being leak tested or inspected, the IBC shall be;

- a. Thoroughly drained of all previous loadings.
- b. Interior washed to remove previous loadings.
- c. Interior rinsed to remove washing materials.
- d. Interior dried to remove liquids.
- e. Exterior washed to remove previous loadings, foreign material, labels and adhesives from all exterior components of the IBC.

The TransCube is manufactured so that it is easy to dismantle for cleaning, servicing, repairs, inspections, etc.. Empty the tank, and follow instructions outlined on the following page.

4.7 CLEANING

Each owner and user of the TransCube should review this manual as part of the regular training and review procedure. Follow all instructions.

1. Remove corner sockets, edging strip and install lifting eyes.
2. With the inner tank emptied of fuel, lift it out using the lifting eyes.
3. Clean the inside of the outer tank (bund). Remove all debris and liquids.
4. Remove the access cover, lift up the back end of the inner tank, and draw off any residue with a pipe inserted into the tank.
5. If it is necessary to enter the tank, care should be taken, and a safe working procedure drawn up and follow it.
6. Pressure wash out the tank, drain tank, then dry. An internal inspection can now be made.

It is recommended the leak test is carried out after the internal inspection. Replace pressure/vacuum relief valve with a plug for the leak test. Reassemble the tank and install a new gasket around the access cover. Secure using 16 1/2" x 1" bolt-nut assemblies. Tighten to 60 ft. lbs. torque to ensure there is no leakage.

- Install a new pressure/vacuum relief valve that is available from Western.
- Leak proof test at 20 kpa for 10 minutes.

With Tank Empty:
1. Remove the corner lifting/stacking sockets.

NOTE

Mark or identify each component prior to removal to allow reassembly in the same location.

2. Remove the edging strip along the top of each side.

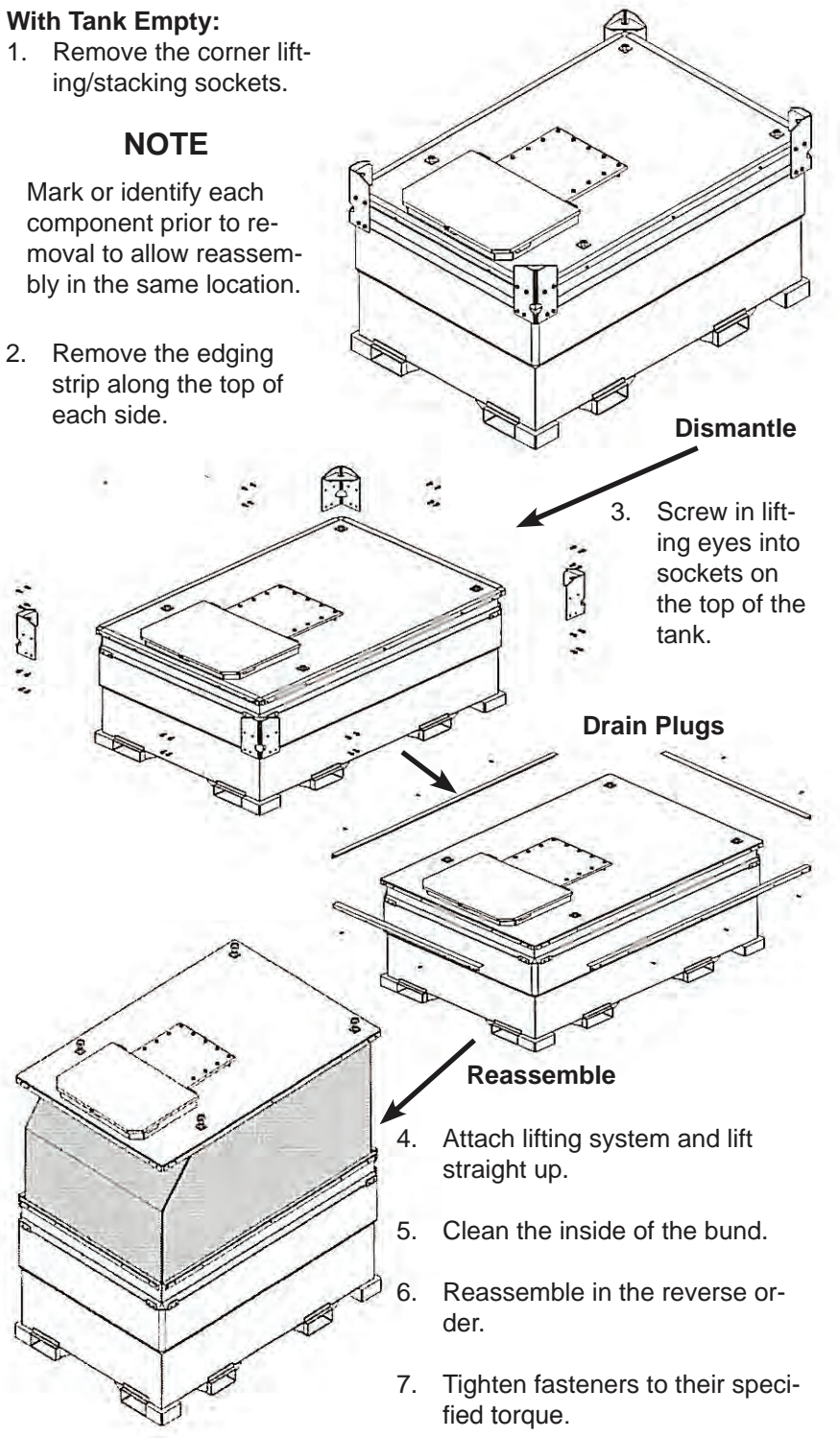

Fig. 22 INNER TANK REMOVAL

3. Screw in lifting eyes into sockets on the top of the tank.
4. Attach lifting system and lift straight up.
 5. Clean the inside of the bund.
 6. Reassemble in the reverse order.
 7. Tighten fasteners to their specified torque.
- Keep records of testing with the unit at all times.

5 RECORD FORM

Use this form to keep track of all tank inspections and testing. Make copies of the next 2 pages for your records.

TRANSCUBE™

Specification Double Wall Mobile Diesel Fuel Tank

Model No.
Serial No.
Capacity
Date

RECORD CARD

THIS RECORD CARD MUST BE KEPT WITH TRANSCUBE, READY FOR INSPECTION AT ALL TIMES

The Transcube is a UN Approved Mobile IBC, PACKING GROUP III. It was leak tested when manufactured and the month and year are recorded on the metal specification plate.

Approval No: 31A/Y****

A leak test & inspection is required every 60 months by a Facility registered by Transport Canada

Owner	Owners Ref. No.
	Pump Type

Every successful leak test and inspection of the Transcube shall be recorded and a copy of the record shall be retained by (1) the Person in charge of the Facility, (2) the Owner of the Transcube. Stamp the month and year on the specification plate.

New gaskets and pressure relief valves available from



Western International Inc.
18 Lois Street
Norwalk, CT 06851
Toll Free: (866) 814-2470
P: (203) 847-4300 F: (203) 847-4310

Date of Test	_____
Name of Test Facility	_____
Address	_____
Results: External	_____
Internal	_____
Components	_____

Date of Test	_____
Name of Test Facility	_____
Address	_____
Results: External	_____
Internal	_____
Components	_____
Date of Next Test	_____

Date of Test _____
Name of Test Facility _____
Address _____

Transport Canada Registration # _____
Results: External _____

Internal _____

Components _____

_____ Date of Next Test _____

Date of Test _____
Name of Test Facility _____
Address _____

Transport Canada Registration # _____
Results: External _____

Internal _____

Components _____

_____ Date of Next Test _____

Date of Test _____
Name of Test Facility _____
Address _____

Transport Canada Registration # _____
Results: External _____

Internal _____

Components _____

_____ Date of Next Test _____

6 TROUBLE SHOOTING

The TransCube is a double walled tank for transporting diesel fuel from one location to another. It is a simple and reliable system that requires minimal maintenance.

In the following section, we have listed many of the problems, causes and solutions to the problems that you may encounter.

If you encounter a problem that is difficult to solve, even after having read through this trouble shooting section, please call your local Western distributor or dealer. Before you call, please have this Operator's Manual from your unit and serial number ready.

PROBLEM	CAUSE	SOLUTION
Pump will not run.	No power.	Connect power wires to 12 volt power source.
	Pump off.	Turn pump on.
<hr/>		
Diesel fuel in interstice.	Loose fitting.	Tighten fitting.
	Leaking coupler.	Replace coupler.
	Over filling tank.	Watch fuel gauge when filling. Do not over fill tank.
<hr/>		
Water in the interstice.	Leaving latch lid open to weather.	Keep latch lid closed.
<hr/>		

7 SPECIFICATIONS

7.1 MECHANICAL

MODEL	CAPACITY		WEIGHT LBS. (Kg)		DIMENSIONS		
	IMP. GAL.	US GAL.	EMPTY	FULL	IMPERIAL / METRIC (MM) LENGTH	WIDTH	HEIGHT
05TCG	110	132	965 LBS (437)	1901 LBS (862)	45 1/4" (1155)	45 1/4" (1155)	33" (838)
10TCG	220	264	1118 LBS (508)	2994 LBS (1358)	45 1/4" (1155)	45 1/4" (1155)	52" (1320)
20TCG	440	528	1825 LBS (828)	5574 LBS (2528)	86 1/4" (2190)	45 1/4" (1155)	52" (1320)
30TCG	660	792	2153 LBS (972)	7765 LBS (3522)	90 1/2" (2300)	59 1/8" (1500)	52" (1320)
50TCG	1040	1247	3567 LBS (1618)	12235 LBS (5550)	90 1/2" (2300)	90 1/2" (2300)	52" (1320)

*ALL WEIGHTS ARE APPROXIMATE

SPECIFICATIONS SUBJECT TO CHANGE WITHOUT NOTICE

7.2 BOLT TORQUE

CHECKING BOLT TORQUE

The tables shown below give correct torque values for various bolts and capscrews. Tighten all bolts to the torques specified in chart unless otherwise noted. Check tightness of bolts periodically, using bolt torque chart as a guide. Replace hardware with the same strength bolt.

ENGLISH TORQUE SPECIFICATIONS

Bolt Diameter "A"	Bolt Torque*					
	SAE 2 (N.m) (lb-ft)		SAE 5 (N.m) (lb-ft)		SAE 8 (N.m) (lb-ft)	
1/4"	8	6	12	9	17	12
5/16"	13	10	25	19	36	27
3/8"	27	20	45	33	63	45
7/16"	41	30	72	53	100	75
1/2"	61	45	110	80	155	115
9/16"	95	60	155	115	220	165
5/8"	128	95	215	160	305	220
3/4"	225	165	390	290	540	400
7/8"	230	170	570	420	880	650
1"	345	225	850	630	1320	970

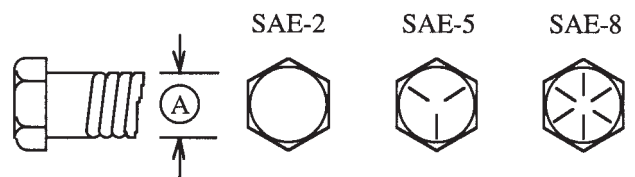

METRIC TORQUE SPECIFICATIONS

Bolt Diameter "A"	Bolt Torque*			
	8.8 (N.m) (lb-ft)		10.9 (N.m) (lb-ft)	
M3	.5	.4	1.8	1.3
M4	3	2.2	4.5	3.3
M5	6	4	9	7
M6	10	7	15	11
M8	25	18	35	26
M10	50	37	70	52
M12	90	66	125	92
M14	140	103	200	148
M16	225	166	310	229
M20	435	321	610	450
M24	750	553	1050	774
M30	1495	1103	2100	1550
M36	2600	1917	3675	2710

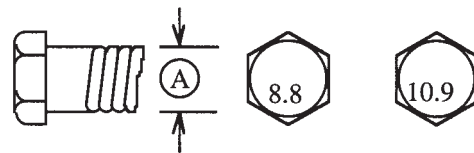

Torque figures indicated above are valid for non-greased or non-oiled threads and heads unless otherwise specified. Therefore, do not grease or oil bolts or capscrews unless otherwise specified in this manual. When using locking elements, increase torque values by 5%.

* Torque value for bolts and capscrews are identified by their head markings.

7.3 HYDRAULIC FITTING TORQUE

TIGHTENING FLARE TYPE TUBE FITTINGS *

1. Check flare and flare seat for defects that might cause leakage.
2. Align tube with fitting before tightening.
3. Lubricate connection and hand tighten swivel nut until snug.
4. To prevent twisting the tube(s), use two wrenches. Place one wrench on the connector body and with the second tighten the swivel nut to the torque shown.

	Tube Size OD (in.)	Nut Size Across Flats (in.)	Torque Value*		Recommended Turns To Tighten (After Finger Tightening)	
			(N.m)	(lb-ft)	(Flats)	(Turn)
	3/16	7/16	8	6	1	1/6
	1/4	9/16	12	9	1	1/6
	5/16	5/8	16	12	1	1/6
	3/8	11/16	24	18	1	1/6
	1/2	7/8	46	34	1	1/6
	5/8	1	62	46	1	1/6
	3/4	1-1/4	102	75	3/4	1/8
	7/8	1-3/8	122	90	3/4	1/8

- * The torque values shown are based on lubricated connections as in reassembly.

TIGHTENING O-RING FITTINGS *

1. Inspect O-ring and seat for dirt or obvious defects.
2. On angle fittings, back the lock nut off until washer bottoms out at top of groove.
3. Hand tighten fitting until back-up washer or washer face (if straight fitting) bottoms on face and O-ring is seated.
4. Position angle fittings by unscrewing no more than one turn.
5. Tighten straight fittings to torque shown.
6. Tighten while holding body of fitting with a wrench.

	Tube Size OD (in.)	Nut Size Across Flats (in.)	Torque Value*		Recommended Turns To Tighten (After Finger Tightening)	
			(N.m)	(lb-ft)	(Flats)	(Turn)
	3/8	1/2	8	6	2	1/3
	7/16	9/16	12	9	2	1/3
	1/2	5/8	16	12	2	1/3
	9/16	11/16	24	18	2	1/3
	3/4	7/8	46	34	2	1/3
	7/8	1	62	46	1-1/2	1/4
	1-1/16	1-1/4	102	75	1	1/6
	1-3/16	1-3/8	122	90	1	1/6
	1-5/16	1-1/2	142	105	3/4	1/8
	1-5/8	1-7/8	190	140	3/4	1/8
	1-7/8	2-1/8	217	160	1/2	1/12

- * The torque values shown are based on lubricated connections as in reassembly.

7.4 TYPICAL UN TEST CERTIFICATE

UN / DOT PACKAGING CERTIFICATION DESIGN QUALIFICATION

PACKAGE DESCRIPTION: WESTERN EXG 3000 Liter MKU IBC

TEN-E PACKAGING SERVICES, INC. certifies that the WESTERN IBC referenced above has passed the standards of the DEPARTMENT OF TRANSPORTATION'S TITLE 49 CFR; Performance Oriented Packaging Standards, Section 178. This package is also certified under IMDG Regulations and the UN Recommendations on the Transport of Dangerous Goods. It is the responsibility of the end user to determine authorization for use under these regulations. The use of other packaging methods or components other than those documented in this report may render this certification invalid.

SUMMARY OF PERFORMANCE TESTS					
UN / DOT TEST	49 CFR REFERENCE	TEST LEVEL	TEST CONTENTS	TEST DATE	TEST RESULTS
Vibration	178.819	3.9 Hz - 60 Minutes	Water	March 8, 2006	PASS
Bottom Lift	178.811	6,227.0 Kg	Water	March 8, 2006	PASS
Top Lift	178.812	10,173.3 Kg	Water	March 8, 2006	PASS
Stack	178.815	8,981.2 Kg - 5 minutes	Water	March 8, 2006	PASS
Leakproofness	178.813	20 kPa	Empty	March 8, 2006	PASS
Hydrostatic	178.814	65 & 200 kPa	Water	March 8, 2006	PASS
Drop	178.810	1.2m	Water	March 8, 2006	PASS
TEST REPORT NUMBER:			06-4010		
UN MARKING: (CFR 49 - 178.703(a))			<div style="border: 1px solid black; border-radius: 50%; width: 20px; height: 20px; display: flex; align-items: center; justify-content: center; margin: 0 auto;"> U n </div> 31A / Y / * * / USA / +AA4841 / 8981 / 4594		
PACKAGING IDENTIFICATION CODE:			31A (178.705)		
PERFORMANCE STANDARD:			Y (Packaging meets Packing Group II & III tests)		
MONTH YEAR OF MANUFACTURE:			** Insert Month & Year of Manufacture		
STATE AUTHORIZING THE MARK:			USA		
PACKAGING CERTIFICATION AGENCY:			(+AA) TEN-E Packaging Services, Inc.		
THIRD PARTY PACKAGE IDENTIFICATION:			+AA		
STACK TEST LOAD:			8,981.2 Kg (19,800.0 Lbs.)		
AUTHORIZED GROSS MASS:			4594 Kg (10,127.9 Lbs.) (Based on 1.2 SG Product)		
DESIGN RE-QUALIFICATION DATE:			March 8, 2007		
ADDITIONAL IBC MARKINGS (CFR 49 - 178.703(b)) :					
RATED CAPACITY AT 20°C (liters):			3000 Liters		
TARE MASS (Kg):			Insert Individual Tare Mass		
DATE OF LAST LEAKPROOFNESS TEST:			Insert Month & Year of last Leakproofness Test		
DATE OF LAST INSPECTION:			Insert Month & Year of Last Inspection		
GAUGE TEST PRESSURE (kPa):			Insert Pressure in kPa if applicable		
BODY MATERIAL AND ITS MINIMUM THICKNESS:			Expressed in mm		
SERIAL # ASSIGNED BY THE MANUFACTURE:			Assigned by manufacturer		

ALL OTHER WARRANTIES, EXPRESSED OR IMPLIED, INCLUDING ANY WARRANTY THAT THE PACKAGING TESTED IS MERCHANTABILITY OR FIT FOR A PARTICULAR PURPOSE, ARE DISCLAIMED. In no event shall TEN-E Packaging Services, Inc. liability exceed the total amount paid by WESTERN for services rendered. In the event of future changes to the above referenced test standard, it is the responsibility of WESTERN to determine whether additional testing or updating of past testing is necessary to verify that the packaging we have tested remains in compliance with those standards.

APPLICANT:

Western
85 Research Drive
Stamford, CT 06906

John Sternquist
John Sternquist
Laboratory Technician
TEN-E Packaging Services, Inc.
1666 County Road 74
Newport, MN 55055

Larry J. Anderson
Larry J. Anderson
Manager, Technical Services
TEN-E Packaging Services, Inc.
1666 County Road 74
Newport, MN 55055

8 INDEX

I	PAGE
Introduction.....	1
 O	
Operation.....	10
Cleaning	28
Controls	13
Field Use	15
Machine Break-In	12
Machine Components.....	11
Pre-Operation Checklist	12
To the New Operator or Owner.....	10
 R	
Record Form.....	29

S	PAGE
Safety	2
Equipment Safety Guidelines	4
General Safety	3
Maintenance Safety.....	7
Operating Safety.....	6
Preparation	6
Safety Signs	5
Safety Training.....	5
Sign-Off Form	8
Storage Safety.....	6
Transport Safety	7
Safety Sign Locations.....	9
Specifications	32
Bolt Torque	33
Hydraulic Fitting Torque.....	34
Mechanical	32
 T	
Trouble Shooting	31

TRANSTM
CUBE



WESTERN ®

WESTERN INTERNATIONAL, INC.
18 Lois Street
Norwalk, CT 06851

ISSUE DATE: MARCH 2010
PART #: TC0213US

T: 203 847 4300
F: 203 847 4310
E: info@western.us.com